

CR2016

Lithium Manganese Dioxide
(Li-MnO₂) Coin Batteries

Specifications

Nominal Voltage	3V
Nominal Capacity*1	80mAh
Max. Discharge Current	3mA
Max. Pulse Current	15mA
Standard Discharge Current	0.1mA
Operating Temperature*2	-20~+70 °C
Approx. Weight	1.8g
UL Component Recognition	MH28717

Dimensions (mm)

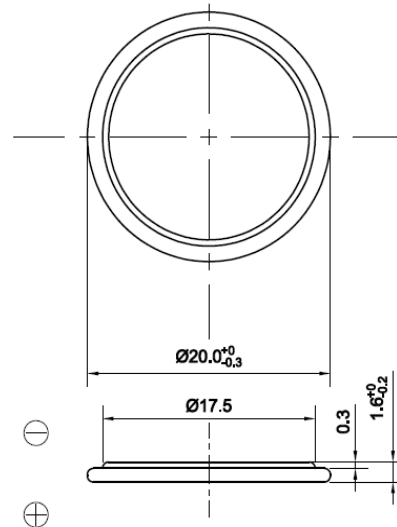

*1 Nominal capacity is determined at an end voltage of 2.0V when the battery is allowed to discharge at a standard current level at 20±3°C.

*2 Consult EVE when using batteries at temperatures exceeding the -10°C to +60°C range.

Performance

Temperature characteristics Load 15KΩ

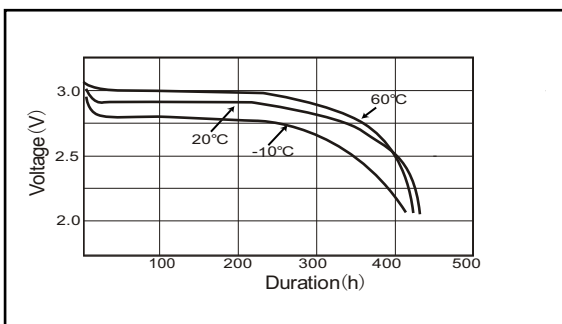

Operating Voltage VS Load Resistance

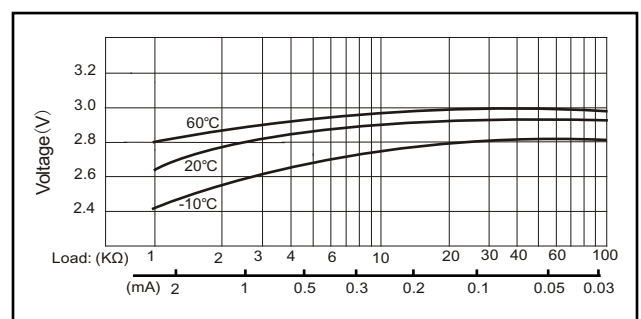

Capacity VS Load Resistance

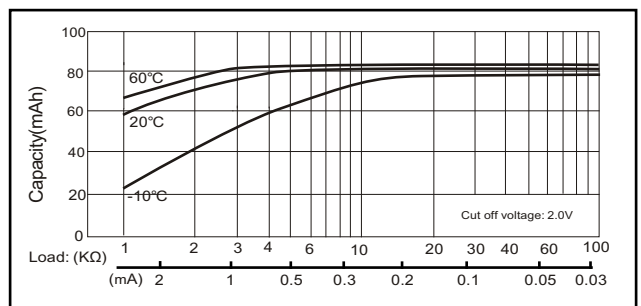

■ Cell and battery designs/specifications are subject to modification without notice, contact EVE for the latest information.

■ Any representations in this data sheet concerning performance are for informational purpose only and are not construed as warranties, either expressed or implied, of future performance.

EVE ENERGY CO., LTD.

Address: NO.38, Hui Feng 7th Road, Zhongkai Hi-Tech Zone, HuiZhou, Guangdong, China

Operator: (86-752)260 6966

Direct: (86-752)260 5822

Fax: (86-752)260 6033

P.C.516006